

INSTRUCTION SHEET



INSTALLATION REQUIRES ONE SIMPLE TOOL: YOUR FOOT.

To use your Footstake Take-Along Table, simply place the stake on the ground pointy side down and step on it with your foot. Once it's secure, snap the Take-Along Table onto the ends. **It's that easy.**

FOOTSTAKE SETUP

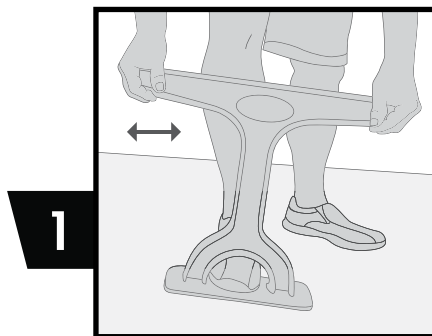

Stabilize the Footstake by holding each side. Use your foot to push down on the Footstake, while rocking the stake slowly side-to-side.

TAKE-ALONG TABLE SETUP

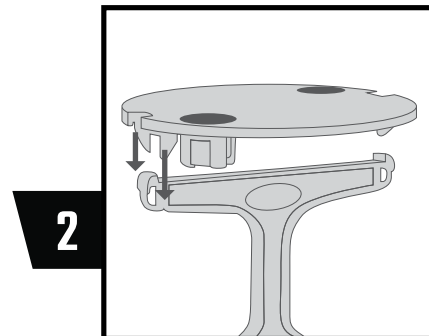

Align and center one end of the table's tabs over the Footstake.

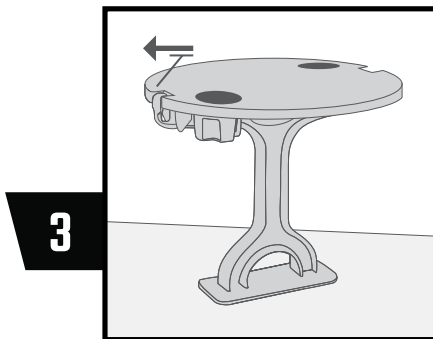

Slide table until it fits tight against the Footstake.

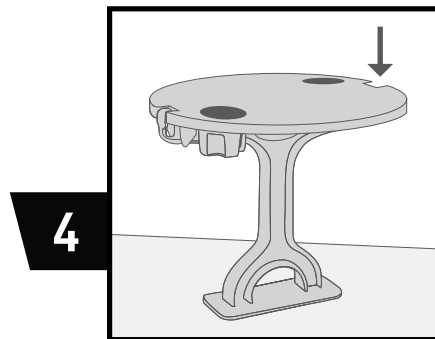

Press the opposite end of the table down onto the Footstake.

TO REMOVE:

Hold the tee from underneath the table with one hand. With your other hand positioned over the table, place your thumb on the end of the tee and use your fingers to grab the end of the table. In one motion, use your thumb as a lever and gently pry up with your fingers, tilting the table up along the length of the tee. Repeat on the other side.

AP0012